

PANEL DOORS

Welcome to Camden

Choosing an entrance for your home is an important decision. The Panel Door range is designed to provide enhanced security, weather performance and energy efficiency, as well as creating a stunning gateway to your home. With a vast range of styles and decorative finishes available, Panel Doors complement any house type.

The range of PVCu doors by Camden are individually manufactured to market-leading specifications, which is why they come with an unrivalled 15 year guarantee.

Camden
15YR
GUARANTEE

Camden
**SAFE &
SECURE**
GUARANTEE

Camden
**ENERGY
EFFICIENT**
GUARANTEE



- 70mm Inliten frame with Steel reinforcement
- Advanced multi-point locking system
- High Impact Resistant Design
- High Performance hardware and furniture



- Designed for maximum weather resistance and energy efficiency
- Available in 28mm or 40mm panel sizes
- Double and triple glazing options
- 15 year guarantee on panels, frames and glass

ENERGY & WEATHER PERFORMANCE

Panel Doors are designed for optimum performance. Manufactured using the toughest and most durable materials, doors are guaranteed to retain their shape and form, will not rot or warp, and require only the minimal amount of maintenance. All panels and

glazing units in the door collection offer excellent energy efficient properties. The core materials of the door panel are bonded together to achieve the highest levels of thermal efficiency. Multi-chambers within the door frame further increases the energy performance.



DOOR MATERIALS

Constructed from compact styrofoam, layers of solid MDF and PVCu inner and outer skins, our panels offer superb levels of strength, durability and energy performance.



ENERGY EFFICIENCY

The core materials of the panel are bonded together, ensuring the highest levels of thermal insulation. For maximum energy performance, select a 40mm panel with a triple glazed unit.



WEATHER PERFORMANCE

Panel Doors offer excellent weather performance properties as standard. The weather-resistant PVCu outer skins and rain deflectors help protect your home during harsh weather conditions.



DOUBLE & TRIPLE GLAZING

Our high performance double and triple glazing units provide excellent insulation and noise reduction. Decorative designs in triple glazing are fitted to the middle pane, protecting them from the elements.

STRENGTH & SECURITY

Constructed from tough, durable PVCu outer-skins, rigid Styrofoam and layers of solid MDF, our Panel Doors offer outstanding levels of strength and impact-resistance. Designed for maximum security,

high performance, advanced multi-point locking systems are fitted to all doors as standard to ensure your home is kept safe and secure.



HIGH SECURITY LOCKING

Keeping your home safe and secure is of utmost importance; which is why all Panel Doors feature multi-point locking mechanisms as standard.



ADVANCED LOCKING

For optimum security, select a hook lock option. Hooks are located at the top and bottom of the locking system and slot firmly into keeps located on the steel reinforced door frame.



STRENGTH & SECURITY

Available with either a 28mm or 40mm panel thickness, Panel Doors are extremely strong, durable and robust. Glazing units can be toughened or laminated for extra security.

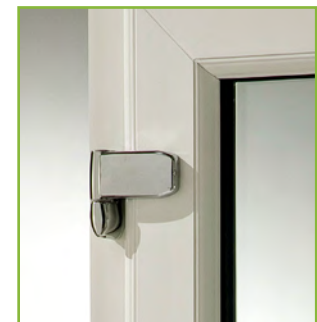

FLAG HINGES

Our doors feature high performance flag hinges to further improve the security and durability of the door. The hinge is 3D adjustable, enhancing ease of use and high visual appeal.

GLASS OPTIONS

For a stunning look, choose one of our bespoke decorative glass designs. Each decorative glass unit is handcrafted in our in-house glass studio and includes a range of intricate designs featuring bevels, tiles, lead, coloured resin and sandblast designs. Decorative glass

options are available for both double and triple glazed applications. In addition to clear glass, we also offer a range of textured/obscure glass options which are designed to enhance the privacy and security of your home. The textured range includes:



Flemish

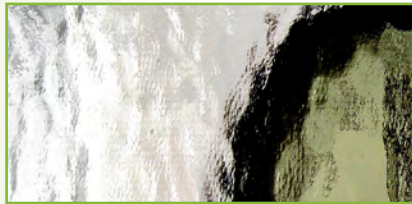

Minster



Charcoal Sticks



Stippolyte



Taffeta

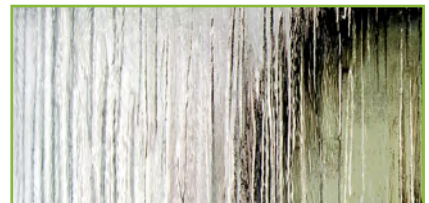

Cotswold



Contora



Autumn Leaf

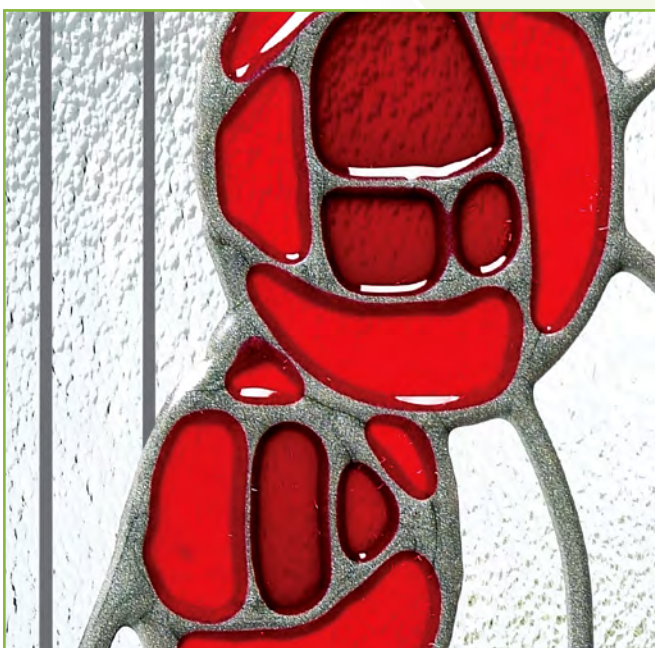

Resin & Lead



Bevel & Lead

COLOUR OPTIONS

Choose from our wide range of panel colours and finishes, from a traditional grain-effect, foiled oak finish to a more contemporary charcoal finish. Alternatively, you can personalise your door by

choosing a sleek spray painted finish to the RAL colour of your choice. Door frames are available to match your door colour selection. In addition to white, the foiled colour range includes:



Whitegrain

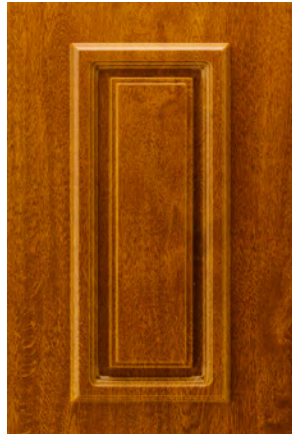

Oak



Cream (RAL9001)



Black (Bog Oak)



Red (RAL3011)



Mahogany

Please note that all RAL coloured finishes in this brochure are for illustration purposes only. Please refer to the RAL colour chart when ordering.



Rosewood



Blue (RAL5011)



Green (RAL6009)



Charcoal Grey (RAL7016)



Amsterdam

This design emulates the traditional old style cottage door. The combination of panelling and our handcrafted glass designs make our Amsterdam door pop-out in any surrounding.

PANELS
28mm & 40mm

GLAZING
24mm Double or
36mm Triple Glazing

Blue - 01
Red - 03
Black - 04

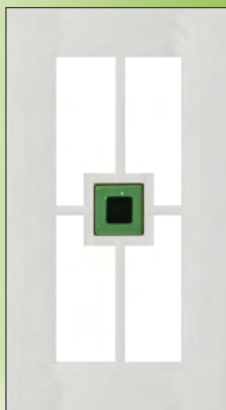

Code: **K1FT-02**

Code: **K1F3**

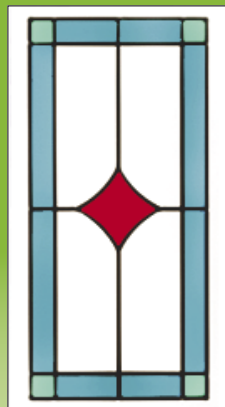

Code: **K1F2**



Blue - 01
Green - 02
Red - 03
Black - 04
Clear - 05

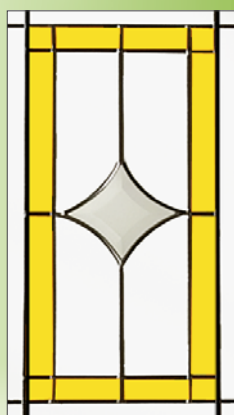

Code: **K1B1-06**

Code: **K1B3**



*Sandblast
Design*
Code: **K1S1**



Code: **K1G**

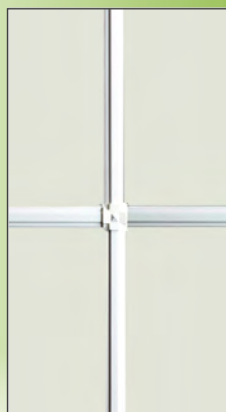

Code: **K1L**

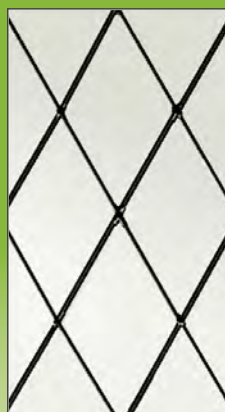

Plain Glass
Code: **K1P**



NEW DESIGN

Example Shown
Code: AD-1FT-01

54



Andorra

Another of our cottage style doors which combines panelling with a modern and dynamic design and glazing element. Perfect for any modern or traditional home.

PANELS
28mm & 40mm

GLAZING
24mm Double or
36mm Triple Glazing

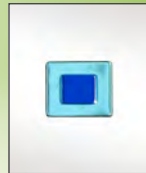
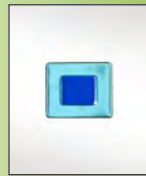
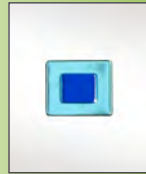
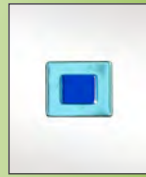

Green - **02**
 Red - **03**
 Black - **04**

Code: **AD-1FT-01**



Code: **AD-1B1**

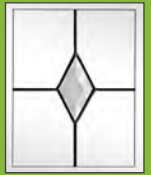

Code: **AD-1B2**



Code: **AD-1G**



Code: **AD-1L**



Code: **AD-1P**

NEW DESIGN



Example Shown
Code: **AW-1FT-01**



Antwerp

Antwerp is a new addition to the cottage style doors which exudes style and confidence with beautiful proportions which will enhance any style of home.

PANELS
28mm & 40mm

GLAZING
24mm Double or
36mm Triple Glazing

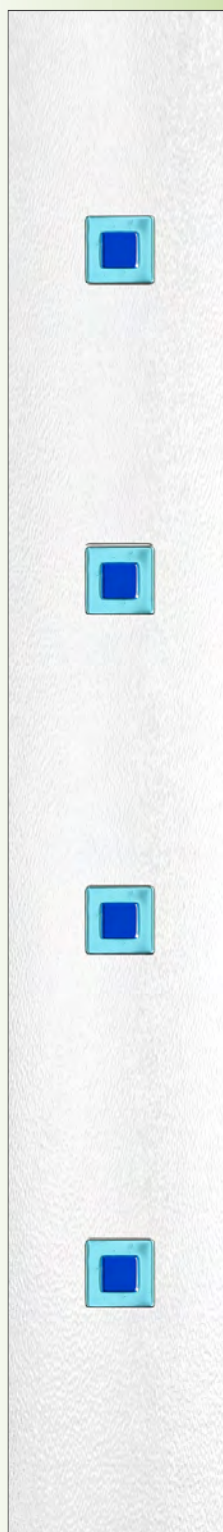

Green - 02
Red - 03
Black - 04

Code: **AW-1FT-01**

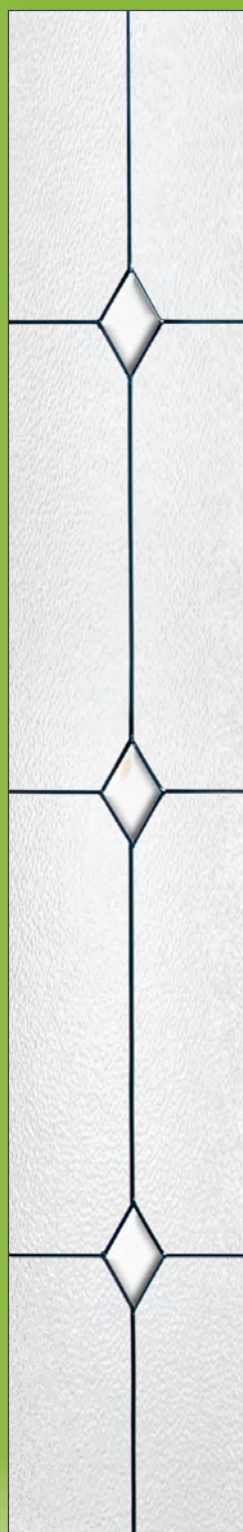

Code: **AW-1B2**



Code: **AW-1P**



Example Shown
Code: F1B4

Athens

Designed to maximise light, the large arch-shaped panel on the Athens makes it an ideal choice when you want to lighten up a darker space. The Athens is available with a wide range of glass and colour options.

PANELS

28mm & 40mm

GLAZING

24mm Double or
36mm Triple Glazing

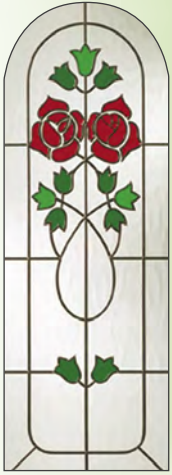

Code: **F1F2**

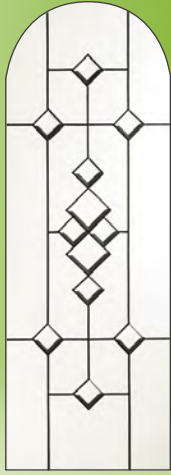

Code: **F1B1**



Code: **F1C2**

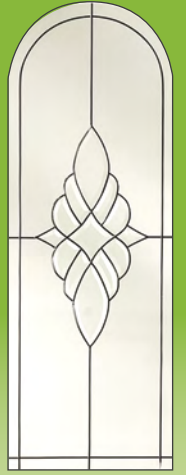

Code: **F1B4**

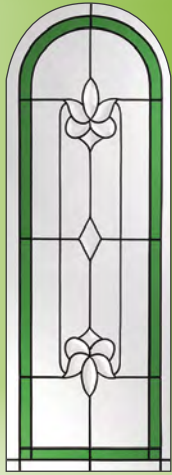

Blue - 01
Red - 03
Black - 04

Code: **F1B-02**

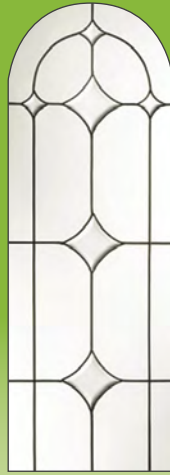

Code: **F1B3**

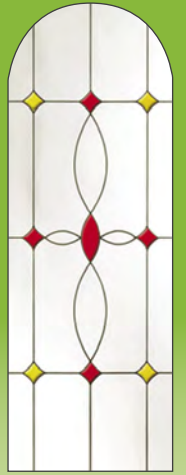

Code: **F1F1**



Code: **F1S2**



Code: **F1G**



Code: **F1L**



Plain Glass
Code: **F1P**



Brussels

One of our most popular door styles, the twin glazed panel Brussels compliments both traditional and modern house styles, and is available in a broad range of colours and decorative glass designs.

PANELS
28mm & 40mm

GLAZING
24mm Double or
36mm Triple Glazing

Blue Code: **A1B1-1**
 Red Code: **A1B1-3**
 Black Code: **A1B1-4**

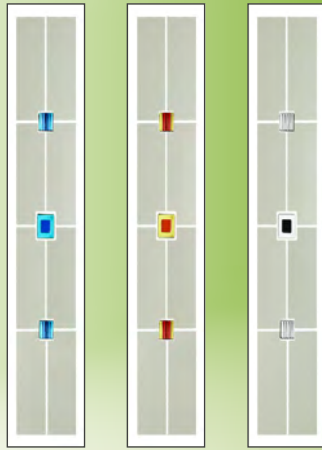

Blue Code: **A1DR1 - 01**
 Green Code: **A1DR1 - 02**
 Red Code: **A1DR1 - 03**
 Black Code: **A1DR1 - 04**

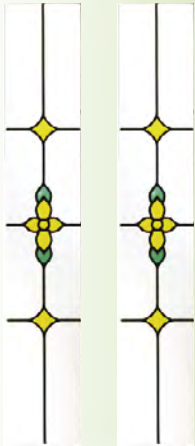
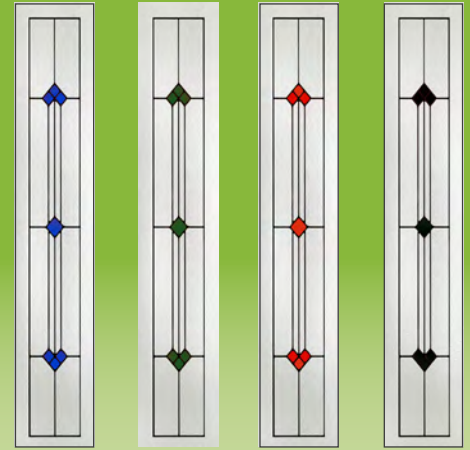

Code: **A1F**

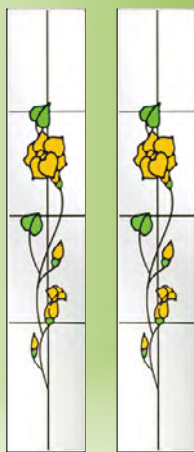

Code: **A1R1**



Code: **A1R2**



Code: **A1B2**

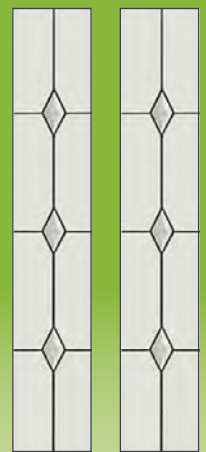

Code: **A1B**



Glass top & bottom
 Code: **A2P**



Solid Panel
 Code: **A00**



Code: **A1L**

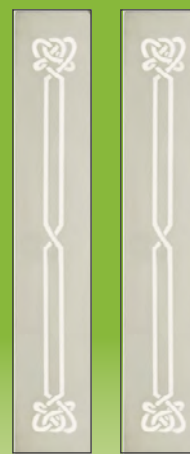

Code: **A1S**



Plain Glass
 Code: **A1P**



Example Shown
Code: **Q1B**

Code: **Q1B**

Cairo

PANELS
28mm & 40mm
GLAZING
24mm Double or
36mm Triple Glazing



Code: **Q1B1**



Code: **Q1F**

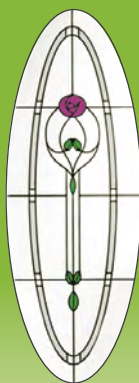

Code: **Q1F2**



Sandblast Design
Code: **Q1S**



Code: **Q1L**

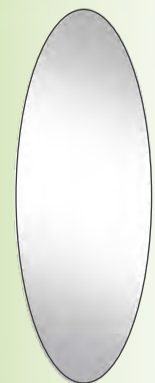

Plain Glass
Code: **Q1P**



Example Shown
Code: **G1B1**

PANELS
28mm & 40mm
GLAZING
24mm Double or
36mm Triple Glazing

Copenhagen



Code: **G1B1**

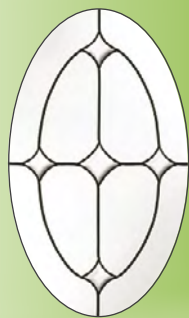

Code: **G1B2**

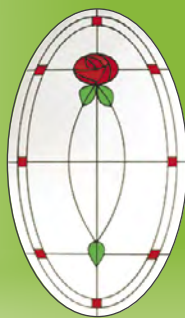

Code: **G1C2**



Code: **G1G**



Code: **G1L**

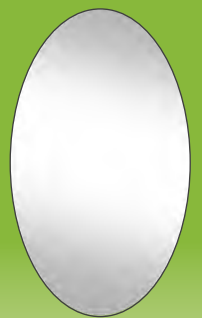

Plain Glass
Code: **G1P**



Example Shown
Code: **C2B**

Dublin

The versatile and popular Dublin range is available as a solid door or with one, three or five glazed panels, with a very broad range of glass styles.

PANELS
28mm & 40mm

GLAZING
24mm Double or
36mm Triple Glazing



Solid Panel
Code: **C00**

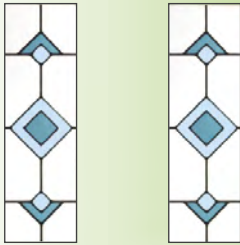
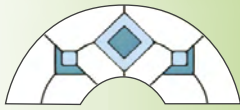

Code: **C2F1**

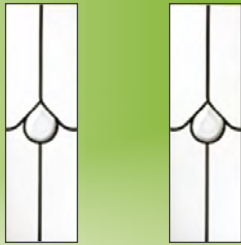

Code: **C2B2**

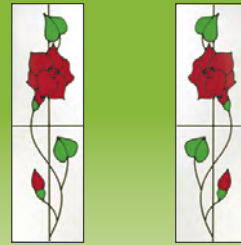

Code: **C2R3**

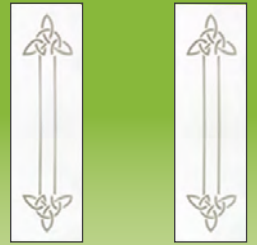

Sandblast Design - Code: **C2S**

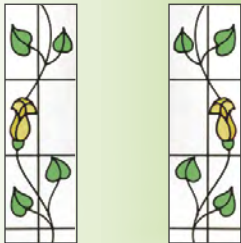

Code: **C2R1**

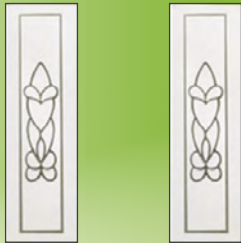

Code: **C2S1**



Code: **C2L**



Plain Glass - Code: **C2P**



Code: **C1F1**



Code: **C1F3**



Code: **C1B1**



Code: **C1B**

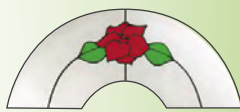

Code: **C1R**



Code: **C1G**



Code: **C1L**



Code: **C1P**



Code: **C3L**



Example Shown
Code: **L1B3**

Madrid

PANELS
28mm & 40mm
GLAZING
24mm Double or
36mm Triple Glazing



Code: **L1B1**

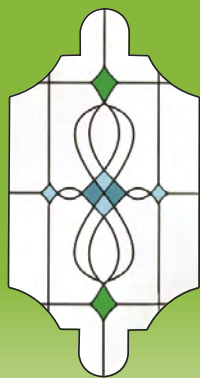

Code: **L1F3**



Code: **L1B3**



Code: **LG**



Plain Glass
Code: **L1P**



Example Shown
Code: **H1B4**

PANELS

28mm & 40mm

GLAZING

24mm Double or
36mm Triple Glazing

Paris

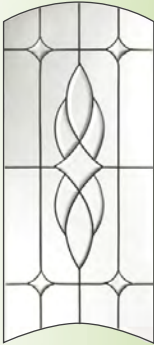

Code: **H1B4**

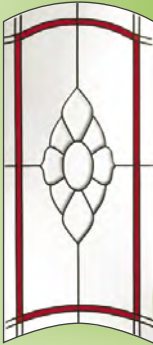

Code: **H1B**

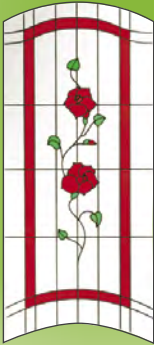

Code: **H1F2**



Code: **H1G**



Code: **H1L**



Plain Glass
Code: **H1P**



Example Shown
Code: D1F1

Prague

The traditional Prague design features a large glazing area to allow light to stream into the hallway, creating a bright, airy feel. The decorative glass options on the Prague add a real personal touch to the door.

PANELS

28mm & 40mm

GLAZING

24mm Double or
36mm Triple Glazing

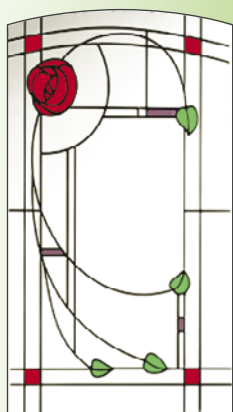

Code: **D1C1**

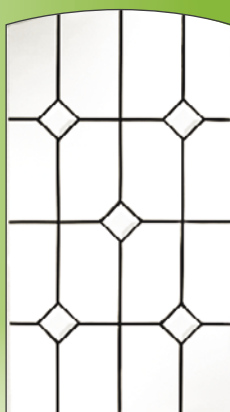

Code: **D1B3**

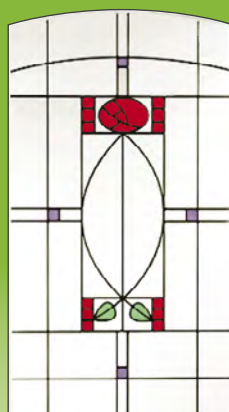

Code: **D1C2**



Code: **D1B4**

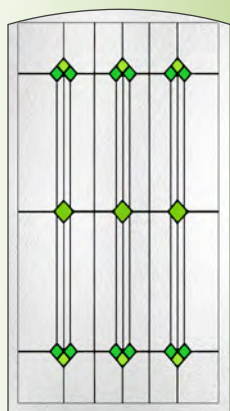

Code: **D1DR1-02**

Blue - 01
Red - 03
Black - 04



Code: **D1F1**

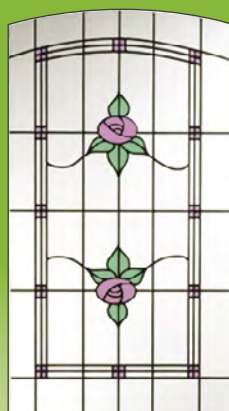

Code: **D1C3**

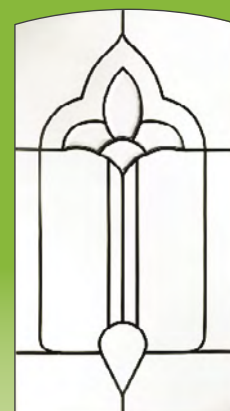

Code: **D1B**



Code: **D1G**



Code: **D1L**



Code: **D1P - Plain Glass**



Example Shown
Code: **B00**
Solid

Example Shown
Code: **B1B1-1**

Rome

PANELS
28mm & 40mm
GLAZING
24mm Double or
36mm Triple Glazing



Code: **B1B1-1**
(Glass top units only)



Code: **B1P**
(Glass top units only)



Code: **B2P**
Plain Glass (Glass top & middle)



Code: **B1L**
(Glass top units only)



Code: **B2L**
(Glass top 2 units only)



B1B1-2



B1B1-3



B1B1-4



Code: **B1Y-1B1**



Designed for convenience, versatility and aesthetic appeal; stable doors are ideal for new build homes or replacement projects, adding extra character to all house types.

Stable doors feature multi-opening facilities: with a glazed top opening and a solid panel bottom opening. These sections can be opened as separate facilities and independent of one another, or alternatively can be opened as a complete unit.

Stable doors may feature a glazing unit or panel/glass unit in the top half of the door, and a solid panel in the bottom half of the door. Alternatively the top section may also be fitted with a Tilt & Turn Window.

Stable Doors

Half Panels

Half panel options allow for a larger glazing area and are ideal if you require extra light into the home.



Half panels are suitable for back door applications, giving extended views over the garden or surrounding area. If you require extra privacy and security, select a textured glass option. Sidelights available as full or half panel.



Monaco
Code: **P70 / P97**



Newry
Code: **R97**



Milan Quarter Panel
Code: **M97**



Oslo
Code: **N97**



Lisburn Flat Panel
Code: **Y00**



Belfast
Code: **S97**



Example Shown
Code: **V1B1**

Vienna

The Vienna is optimised to allow the maximum amount of light through the door - this both highlights the glass design and the surrounding relief pattern on the panelling itself.

PANELS
28mm & 40mm

GLAZING
24mm Double or
36mm Triple Glazing

Code: **V1B2**



Code: **V1B4**



Sandblast Design
Code: **V1S1**



Blue - **01**
Red - **03**
Black - **04**
Code: **V1B-02**

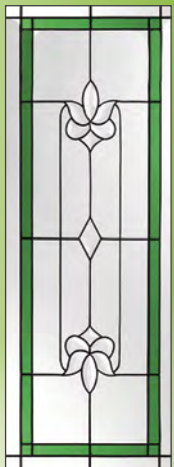

Code: **V1DB6**



Sandblast Design
Code: **V1S**



Code: **V1G**



Code: **V1L**



Plain Glass
Code: **V1P**



DOOR GLASS AND MATCHING SIDELIGHTS

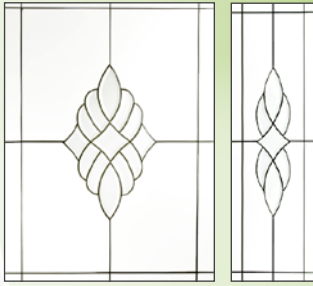

Code: **DD1B5**

Code: **SD1B5**

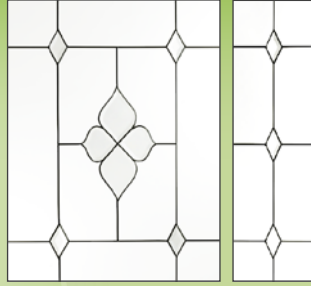

Code: **DD1B2**

Code: **SD1B2**

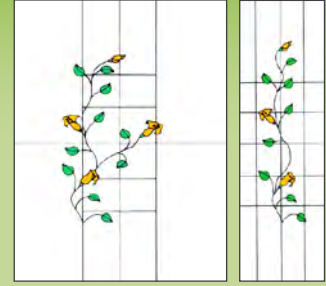

Code: **DD1F3**

Code: **SD1F3**

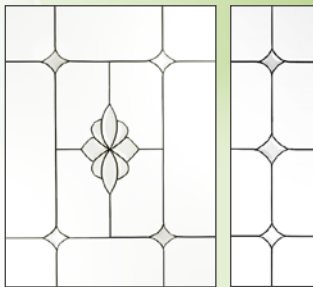

Code: **DD1B6**

Code: **SDB1L1**

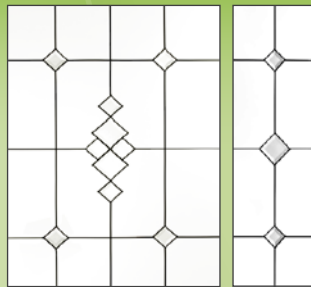

Code: **DD1B7**

Code: **SD1B7**

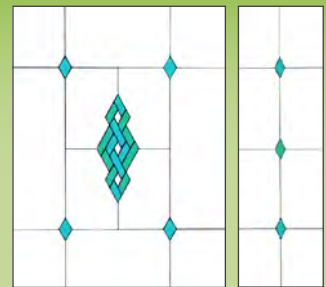

Code: **DD1F4**

Code: **SD1F4**

SIDELIGHTS

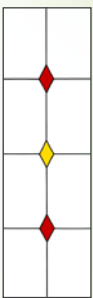

Code: **SD1F1**



Code: **SD1G1**

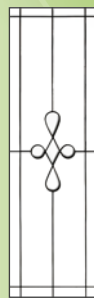

Code: **SDG1B**



Code: **SD1F2**



Code: **SDB1L**



Code: **SDA1B1**



Code: **SDQ1S**

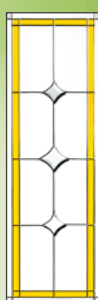

Code: **SDK1B1**



Code: **SDF1B2**

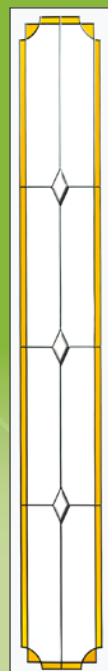

Code: **SDV1B1**



Code: **SDH1F**



Code: **CD1B6**



Code: **CD1B7**



Code: **CD1B8**



Code: **CD1B5**



Code: **CD1B1**



Code: **CD1F10**

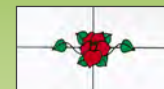

Code: **CD1F11**

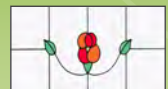

Code: **CD1F14**

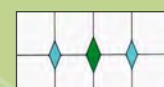

Code: **CD1F12**



Code: **CD1F13**

TOPLIGHTS

Personalise the top section of your half panel door with a mullion and decorative glass option.

Extra surcharges & turnarounds may apply for any non-standard elements.

ACCESSORIES

LEVER/LEVER HANDLES

THUMB-TURN CYLINDER



Gold



Silver



Black



White



Fitted to the inside of the door; thumb mechanism engages lock.

LEVER/PAD HANDLES



Gold



Silver



Black



White

The pull pad is fitted to the outside of the door and locks automatically when the door is closed; access can only be gained using the door key.

LETTERBOXES



Gold

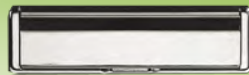

Silver

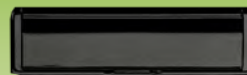

Black



White

URN DOOR KNOCKER available with/without peephole

SCROLL DOOR KNOCKER

LION DOOR KNOCKER



Gold



Silver



Black



Gold



Black



Gold



Black



PVC Threshold

76mm PVC as standard; 50mm & 60mm options also available.



Stormguard Threshold

Provides enhanced weather-resistance and accessibility. Available in silver or gold finishes.

Detachable ramps for wheelchair access available upon request.

TECHNICAL INFORMATION

Lisburn Flat Panel Option

795 x 1940 - W00

895 x 2090 - X00

895 x 1045 - Y00

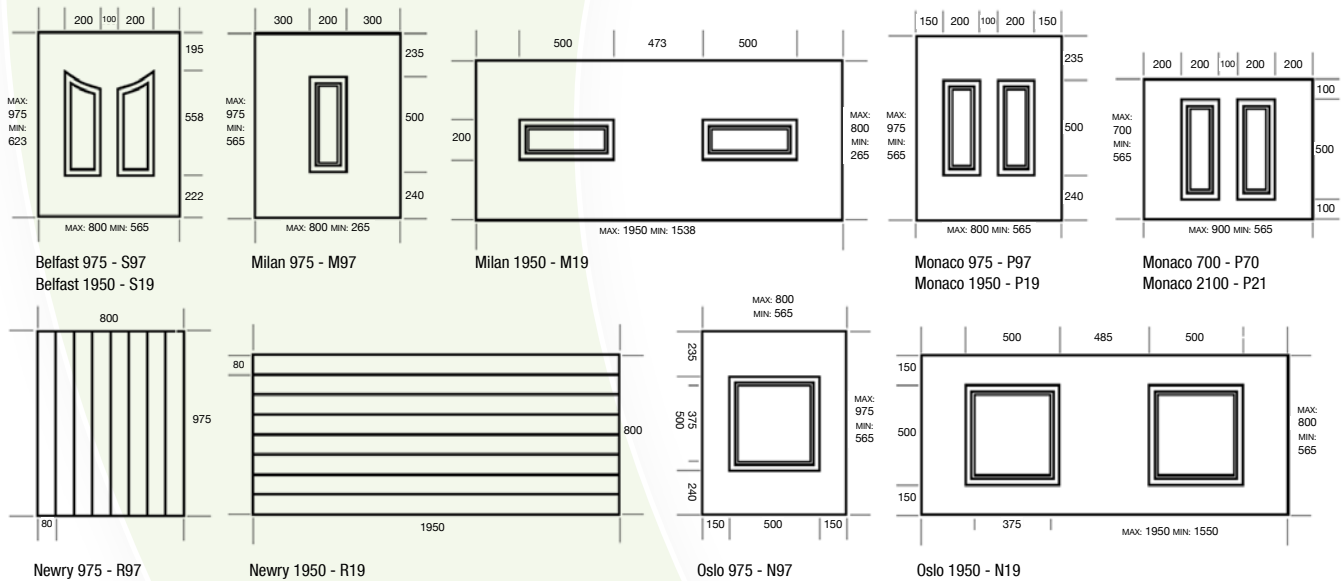

PANELS

Panels are constructed from a compact styrofoam core, layers of MDF, with PVCu external and internal skins. Panels are available with a 28mm or 40mm thickness.

PANEL COLOURS

Standard colours: White, Black, Cream, Oak, Rosewood and Mahogany. Other colours available: Red, Blue, Green and Charcoal. Spray-painted RAL colours also available. Please contact us for full range of RAL colours - please note that longer turnarounds and extra surcharges apply for spray painted panels/doors. NB: Black panels are 'Bog Oak Black' to match foiled frame.

PVCu FRAME

Inliten PVCu 70mm system with steel reinforcement. Frame colour range includes: White, Black, Cream, Oak, Rosewood, Mahogany, Red, Blue, Green & Charcoal Grey or a spray-painted RAL colour of your choice (please note that longer turnarounds and extra surcharges apply for spray painted products).

LOCKING

Advanced multi-point locking mechanisms & hardware fitted as standard. For enhanced security, select Hook Locks.

HANDLES & HINGES

Lever/lever handles fitted as standard. Lever/pad and thumb-turn options also available. Available in White, Black, Gold or Silver. Flag hinges as standard, available in White, Black, Silver or Gold.

DOOR FURNITURE

Letterboxes available in white, black, silver and gold. Urn knockers (with/without peephole) are available in black, silver or gold. Scroll and Lion knockers available in black or gold only. Numerals and chains may also be supplied as a non-fitted accessory. Please note letterbox options are not available with panel style 'Paris' under 1760mm high.

GLAZING

Glazing unit is 24mm on 28mm panels and 36mm on 40mm panels. Double and triple glazing options available. Glass units are toughened on both sides. Range of textured glass options also available. Georgian Bar only available in white, cream, oak, black and rosewood.

BACKING GLASS

Backing glass for glazing units are available - please select from our textured glass options on page 7.

SIDELIGHTS

A range of full and half sidelights options are available - please see page 28.

THRESHOLD

76mm PVC threshold as standard, 50mm & 60mm also available. Stormguard thresholds available as optional extra.

GUARANTEE

15 year guarantee on PVCu frames and panels (white and foiled). 10 year guarantee on spray painted products. 1 year on ironmongery.

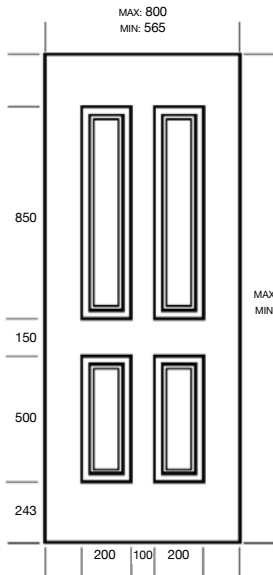

A/Brussels

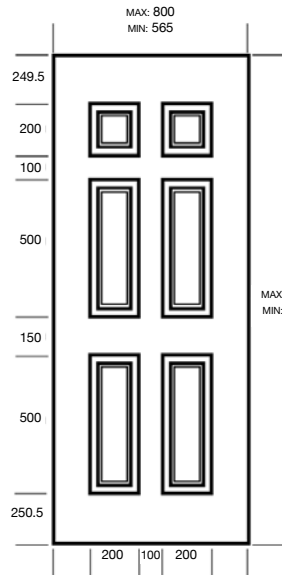

B/Rome

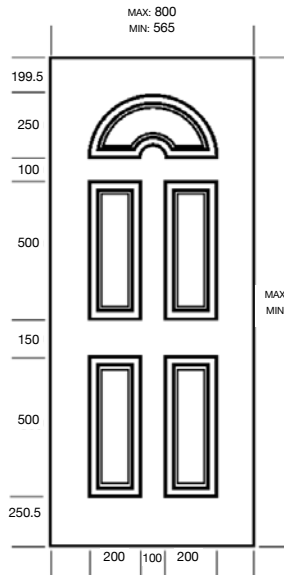

C/Dublin

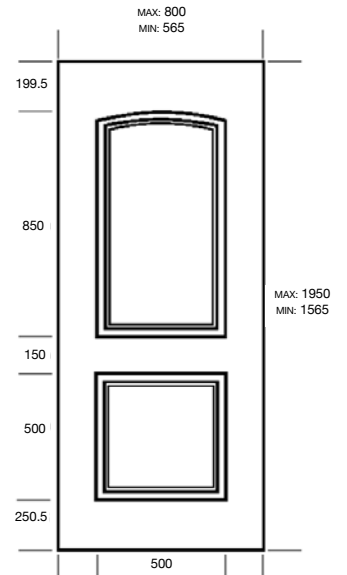

D/Prague

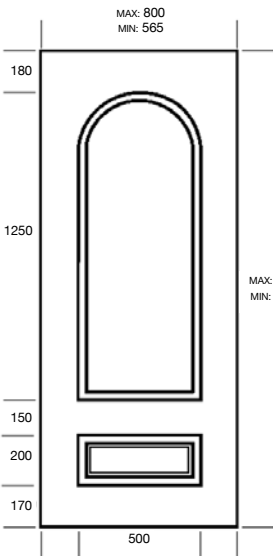

F/Athens

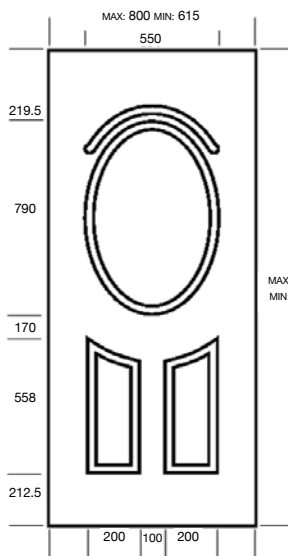

G/Copenhagen

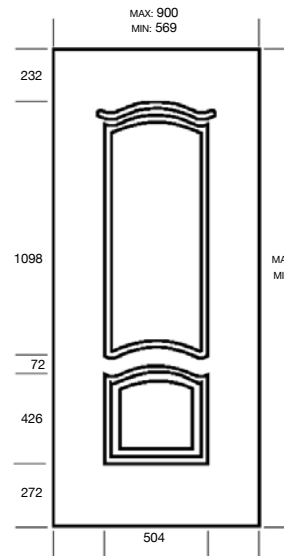

H/Paris

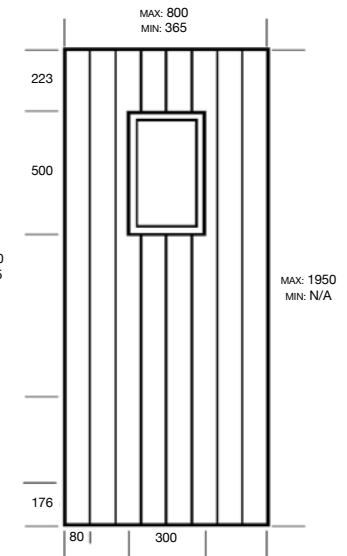

K/Amsterdam

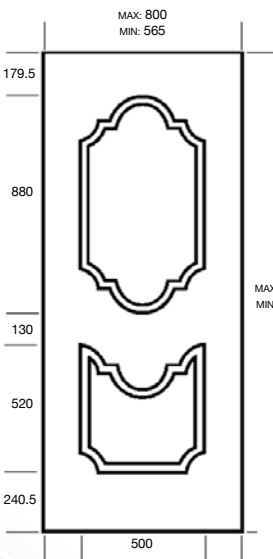

L/Madrid

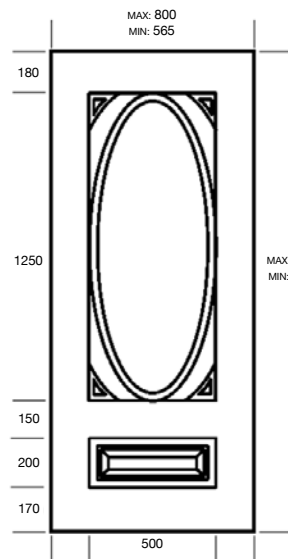

Q/Cairo

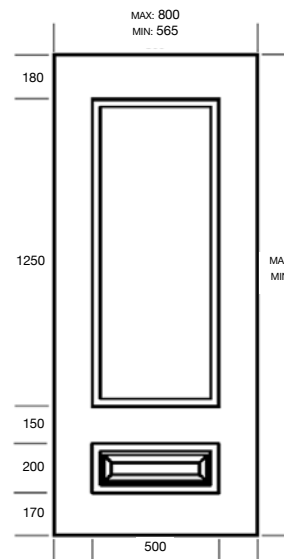

V/Vienna

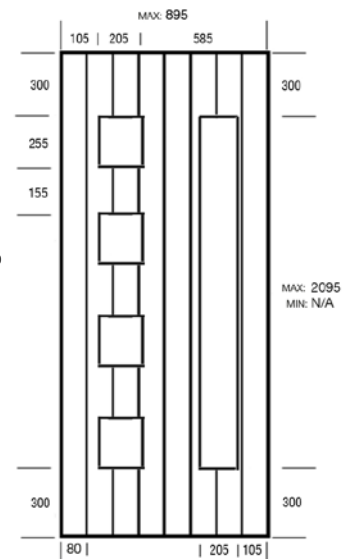

AD/AW Andorra/Antwerp

www.camdengroup.co.uk
0800 470 3204
sales@camdengroup.co.uk



4-7 Steeple Road Industrial Estate, Antrim, BT41 1AB

Copyright © Camden Group.
Subject to Camden Group Terms
& Conditions. Images are for
illustration purposes only and may
differ from product supplied. All
content is correct at time of print
and may be subject to change at
the discretion of Camden Group.

Vers: SL-PD-10/17